



Finesse™ Peak®

Headerless frameless pivot shower door
5699-39

Features

- CleanCoat®+ glass coating creates a hydrophobic barrier that repels water, soap scum, and residue, saving time and protecting shower doors 10 times longer than original CleanCoat. (Based on 2021 internal wear/abrasion testing using a microfiber cloth.)
- Tempered glass ensures enhanced safety and durability.

Material

- Heavy 5/16" (8 mm) glass for strength and stability.

Installation

- Out-of-plumb adjustability simplifies installation.
- Door can be installed to open to the left or right to suit your bathroom layout.
- Not for use in hospitality.
- For residential use only.

Included Components

Additional Components:
Hardware kit



Codes/Standards

ANSI Z97.1
CPSC 16CFR 1201

STERLING® Warranty - Bath and Shower Doors

See website for detailed warranty information.

Available Colors/Finishes

Color tiles intended for reference only.

Color	Code	Description
	ADR	Anodized Deep Bronze
	ADR	Anodized Deep Bronze
	N	Nickel
	N	Nickel
	S	Silver
	S	Silver

Available Glass Options

Code	Description
G05	Clear
G03	Frosted

1-800-STERLING (1-800-783-7546)

Kohler Co. reserves the right to make revisions without notice to product specifications.

For the most current Specification Sheet, go to www.sterlingplumbing.com.

10-5-2022 00:26 - US//CA

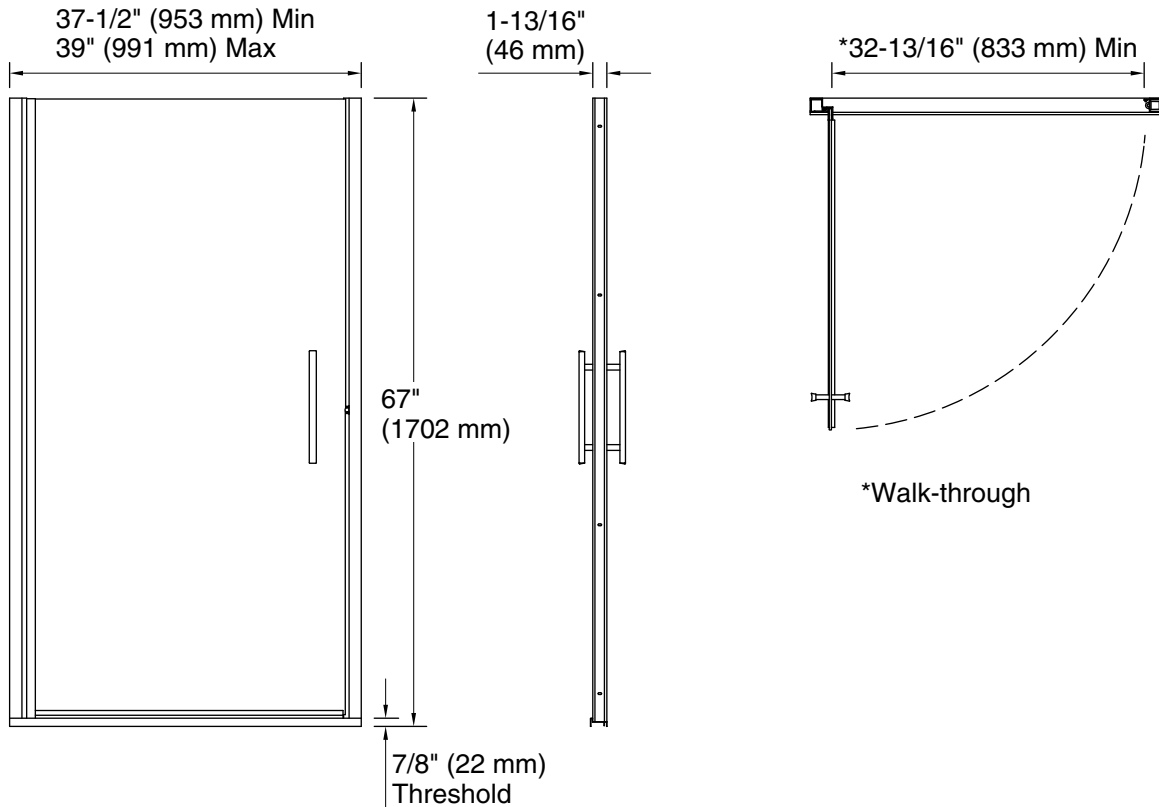

Technical Information

All product dimensions are nominal.

Installation type:	For shower base installation
Opening Width - Min:	37-1/2" (953 mm)
Opening Width - Max:	39" (991 mm)
Walk-through - Min:	32-13/16" (833 mm)
Base-To-Wall Radius - Max:	1/2" (13 mm)
Glass thickness:	5/16" (8 mm)
Glass coating:	CleanCoat®

Notes

Install this product according to the installation instructions.

The vertical opening should be a minimum of 67" (1702 mm) to allow for installation clearance.